

Data sheet: SiBoost Smart 3 Helix V 1004

Pump curves

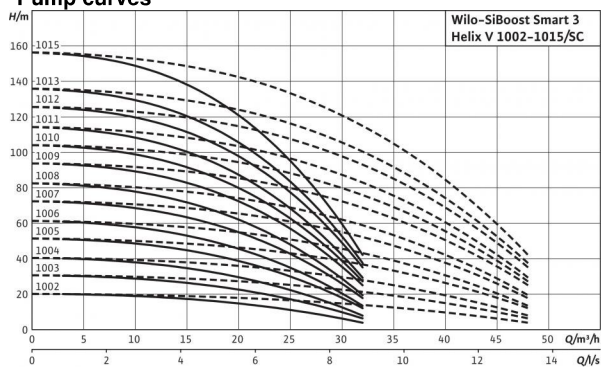

---- including standby pump

Dimension drawing

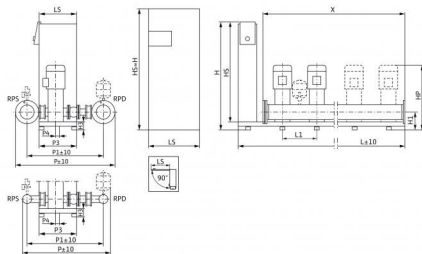

Sample systems are shown.

Accessories (to be ordered separately): Optional WMS low-water cut-out switchgear kit;

Installation surface: flat and horizontal

Installation location: dry, well ventilated and frost-proof

A working area of 1 m around the system is recommended in order to facilitate the maintenance process.

Power

Max. fluid temperature T	50 °C
Max. ambient temperature T	40 °C
Maximum operating pressure p_{max}	16 bar
Nominal diameters of the pipe connections on suction side RPS	R 2½
Nominal diameters of pipe connections on the pressure side RPD	R 2½
Number of stages	4
No. of standby pumps	1
No. of duty pumps	2

Motor

Mains connection	3~400 V, 50 Hz
Permitted voltage tolerance	±10 %
Insulation class	F
Protection class	IP 55
Rated power P_2	1.50 kW
Nominal current 3~230 V, 50 Hz I_N	5.40 A
Nominal current 3~400 V, 50 Hz I_N	3.10 A
Motor efficiency η_m 50%	80.5 %
Motor efficiency η_m 75%	83.7 %
Motor efficiency η_m 100%	84.2 %

Materials

Pump housing	1.4301 [AISI304]
Pump shaft	1.4301 [AISI304]
Impeller	1.4307 [AISI304L]
Static seal	EPDM
Mechanical seal	Q1BE3GG

Information for order placements

Make	Wilo
Type	SiBoost Smart 3 Helix V 1004
Art no.	2536090
Weight approx. m	217 kg

• = available, - = not available

Dimensions and dimensions drawings: SiBoost Smart 3 Helix V 1004

Dimension drawing

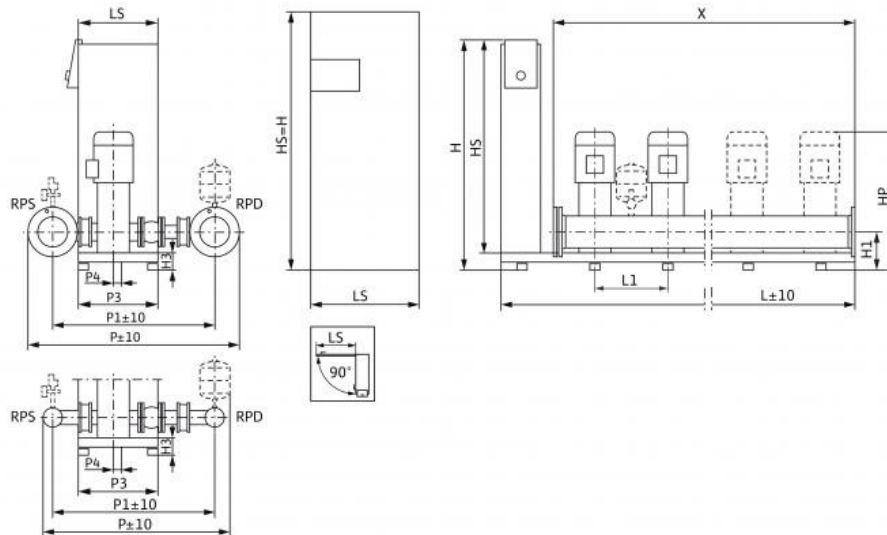

Sample systems are shown.

Accessories (to be ordered separately): Optional WMS low-water cut-out switchgear kit;

Installation surface: flat and horizontal

Installation location: dry, well ventilated and frost-proof

A working area of 1 m around the system is recommended in order to facilitate the maintenance process.

Nominal diameters of pipe connections on the pressure side <i>RPD</i>	R 2½
Nominal diameters of the pipe connections on suction side <i>RPS</i>	R 2½
Dimensions <i>H</i>	1055 mm
Dimensions <i>H1</i>	170 mm
Dimensions <i>H3</i>	90 mm
Dimensions <i>HP</i>	821 mm
Dimensions <i>HS</i>	950 mm
Dimensions <i>L</i>	1150 mm
Dimensions <i>L1</i>	300 mm
Dimensions <i>LS</i>	400 mm
Dimensions <i>P</i>	845 mm
Dimensions <i>P1</i>	704 mm
Dimensions <i>P3</i>	420 mm
Dimensions <i>P4</i>	30 mm
Dimensions <i>X</i>	900 mm

Pump curves: SiBoost Smart 3 Helix V 1004

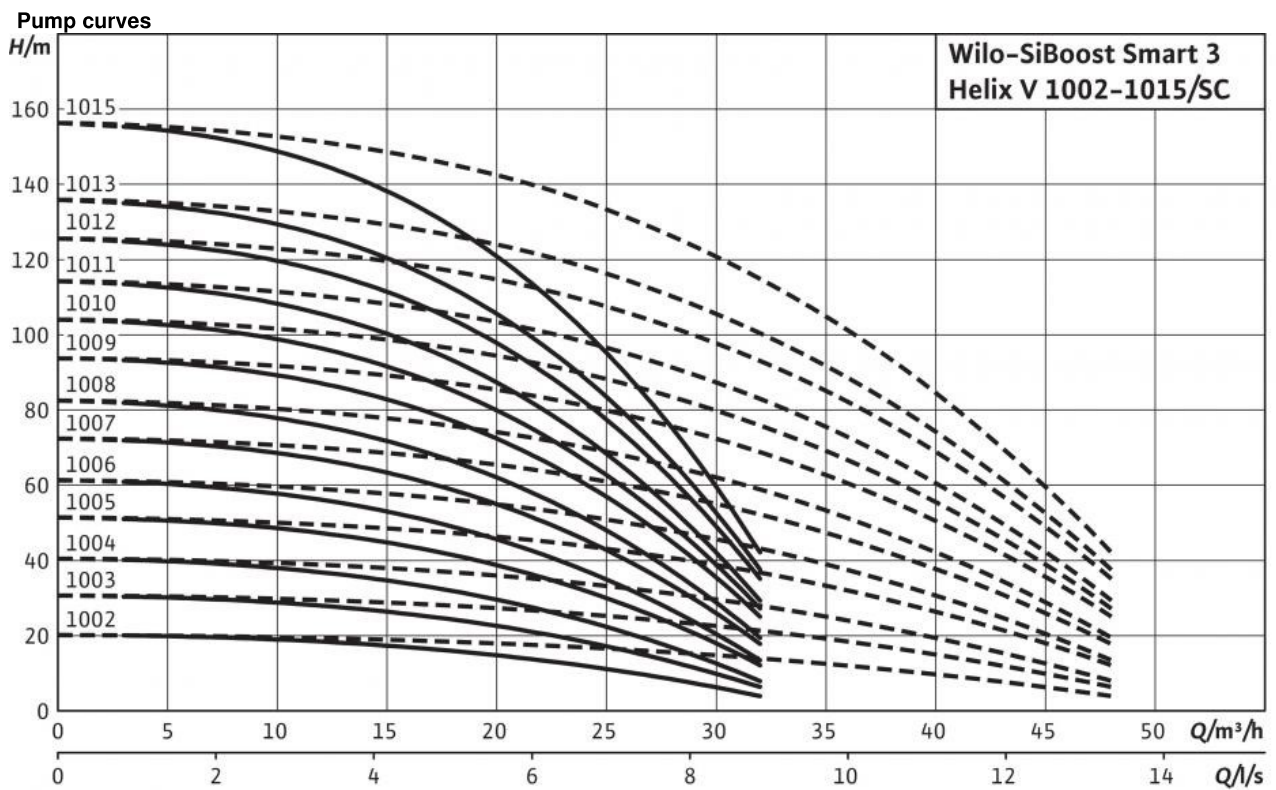

---- including standby pump

Terminal diagram: SiBoost Smart 3 Helix V 1004

Terminal diagram Smart Controller SC, direct starting

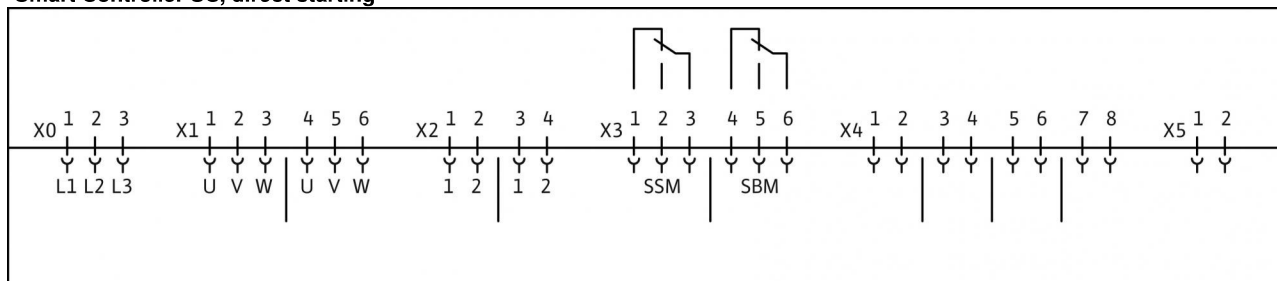

x0: Mains connection

x1: Power supply, pumps 1-3, pump 1; 4-6, pump 2

x2: Connection WSK 1-2, pump 1; 3-4, pump 2; etc.

x3: Potential-free contacts (signals) 1-3, SSM (collective fault signal); 4-6, SBM (collective run signal)

x4: Connections for sensor 1, sensor (In); 2, sensor (+) 3-4, external On/Off; 5-6, TLS (dry-running protection); 7-8, setpoint 2

x5: Analogue outputs 1-2, actual pressure (0...10 V)

Ordering information: SiBoost Smart 3 Helix V 1004

Make	Wilo
Type	SiBoost Smart 3 Helix V 1004
Art no.	2536090
EAN number	4048482225616
Colour	Green/black/silver
Minimum order quantity	1
Minimum order quantity unit	PCE
Weight (net) <i>kg</i>	217
Length (net) <i>mm</i>	1150
Width (net) <i>mm</i>	845
Height (net) <i>mm</i>	1055
Weight (gross) <i>kg</i>	242
Length (gross) <i>mm</i>	1300
Width (gross) <i>mm</i>	1050
Height (gross) <i>mm</i>	1260
Packaging type	Special pallet
Packaging property	Transport packaging
Pieces per pallet	1
Number per layer	1

Tender text: SiBoost Smart 3 Helix V 1004

Compact pressure boosting system according to DIN 1988 and DIN EN 806, for direct or indirect connection. Consisting of non self-priming, switched in parallel, vertically-mounted stainless steel high-pressure centrifugal pumps in glanded versions. Ready for connection with stainless steel pipework, mounted on a base frame, including control device with all necessary measurement and adjustment equipment.

For fully automatic water supply and pressure boosting in residential, commercial and public buildings, hotels, hospitals, department stores and for industrial systems.

For pumping drinking water, process water, cooling water, fire water (apart from fire-extinguishing systems in accordance with DIN 14462 and with the approval of the local fire safety authorities) or other types of industrial water that do not attack the materials either chemically or mechanically and do not contain abrasive or long-fibre constituents.

Special features/product benefits

- Heavy-duty system which satisfies all the requirements of DIN 1988 (EN 806)
- WRAS/ KTW/ ACS approval of the pumps for all parts that come in contact with the fluid (EPDM version)
- High-efficiency pump hydraulics of the Helix V series in conjunction with IE2 IEC standard motors, including 7.5 kW and larger IE3 standard motor (optional for smaller motor power)
- Bidirectional mechanical seals in the pumps for easy maintenance
- Flexible lantern design permits direct access to the mechanical seal
- The spacer coupling enables the mechanical seal to be replaced without dismantling the motor (from 7.5 kW)
- Hydraulics of entire system are pressure-loss optimised.
- Parts that come in contact with the fluid are corrosion-resistant
- Comfort control device SC, maximum degree of control with symbol-based LC display, simple navigation with clear menu and red-button technology for parameter setting
- Factory inspection and default setting at optimum operating range (incl. acceptance test certificate based on EN10204 - 3.1)

Equipment/function

- Stainless steel high-pressure centrifugal pumps of the Helix V series
- Base frame of electrolytically galvanised steel, with height-adjustable vibration absorbers for insulation against structure-borne noise
- Shut-off valve on the suction and pressure sides of each pump
- Non-return valve on the pressure side of each pump
- 8 litre diaphragm pressure vessel, PN16 including throughflow fitting to DIN 4807, pressure side
- Pressure sensor (4-20 mA), pressure side
- Pressure gauge, pressure side
- Automatic pump control by means of a fully electronic

Smart-Controller (SC) in a sheet metal enclosure, protection class IP 54 consisting of internal power supply unit, microprocessor with soft PLC, analogue and digital inputs and outputs.

A working area of 1 m around the system is recommended in order to facilitate the maintenance process.

Operation/ display

- LC display (backlit) for display of the operating data, controller parameters, operating statuses of the pumps, error messages and history log
- Menu navigation with symbols and menu numbers
- LEDs for display of the system status (operation/fault)
- Factory-preset parameters for easy commissioning/start-up
- Configuration of operating parameters and acknowledgement of fault signals using red-button technology
- Lockable main switch
- Operation selectable with / without standby pump by customer service
- Elapsed time indicator for each pump and for entire system
- Switching cycle counter for each pump and for entire system
- Fault log for the last 16 faults

Control

- Fully automatic control for 1 to 4 uncontrolled pumps by means of setpoint/actual value comparison
- Setpoint changeover: 2nd setpoint can be activated by contact
- External remote setpoint adjustment by 4...20 mA signal
- Automatic, load-sensitive cut-in of 1 to n peak-load pump(s) depending on the pressure - constant, p-c control variable
- Contactors for switching on the pumps. SD models include thermal triggering and a timer relay for the star-delta combination
- 2 parameter sets selectable, easy menu (setpoint & control mode) or expert menu (operation and control parameters)
- Operating mode of the pumps freely selectable (manual, off, automatic)
- Automatic, configurable pump cycling
 - Standard setting: Impulse - The base-load pump is cycled at each new demand, regardless of operating hours
 - Alternative: Pump cycling dependent on operating hours, cycling of the base-load pump after the specified operating hours
- Automatic, configurable pump test run (pump kick)
 - Can be activated/deactivated
 - Time between two test runs is freely programmable
- Disabling times can be programmed as desired

Tender text: SiBoost Smart 3 Helix V 1004

Monitoring

- Actual value of the system is output via a 0-10 Volt analogue signal for external measurement / display applications, 10 Volt depending on the sensor range value
- 4-20mA sensor signal (conductivity test of the sensor cable) for control variable actual value
- Protection of the pump motors in the DOL version: via motor protection switch; in the SD version: Fuses in combination with thermal triggering
- Automatic changeover to the standby pump in the event of a operating pump fault
- Monitoring of maximum and minimum system values with adjustable time delays and limits
- Zero-flow test for switching off the system when no water is being drawn off (adjustable parameters)
- Pipe filling function for filling empty pipes (initial filling of the consumer network)
- Protection against low water level via contact e.g. for float switch or pressure switch

Interfaces

- Potential-free contacts for SBM/SSM collective operation and collective fault signals
- Logical reversal can be applied to SBM and SSM
- Contacts for external on/off, low water and 2nd setpoint
- External on/off via contact for deactivation of the system's automatic mode

Optional accessories (factory installation or retrofitting after technical checks)

- Manual-0-Automatic switch Preselection of the operating mode of each pump and manual operation in the event of a controller fault "Manual" (emergency/test mode available at mains power, motor protection available), "O" (pump switched off – cannot be switched on using the controller) and "Auto" (pump enabled for automatic mode via the controller)
- Evaluation relay for PTC motor protection
- Individual operation and fault signal, low-water signal
- Signal converter for 0/ 2-10V to 0/ 4-20mA
- Soft starter for peak-load pumps
- Connection to BMS systems in accordance with VDI 3814

Recommended accessories (to be ordered separately)

- Optional WMS low-water cut-out switchgear kit;
- Flexible connection lines or expansion joints
- Break tank for system separation
- Diaphragm pressure vessel
- Threaded caps for systems with threaded joint tubing

Bus systems (optional)

- BACnet, LON-Bus, Modbus RTU

Standards followed

- Specifications for drinking water installations (TRWI) DIN 1988 (EN806)
- Diaphragm pressure vessel/ diaphragm expansion tank DIN 4807
- Electronic Equipment for Use in Power Installations (EN 50178)
- Electrical Equipment of Machines (EN 60204-1)
- Household and Similar Electrical Appliances - Safety (EN 60335-1)
- Low-voltage switchgear combinations EN 60439-1/ 61439-1
- EMC - Immunity for Industrial Environments (EN 61000-6-2)
- EMC - Emission Standard for Residential, Commercial and Light-Industrial Environments (EN 61000-6-3)

Power

Max. fluid temperature T : 50 °C

Max. ambient temperature T : 40 °C

Standard version for operating pressure p_{max} : 16 bar

Number of stages: 4

No. of standby pumps: 1

No. of duty pumps: 2

Motor

Mains connection: 3~400 V, 50 Hz

Permitted voltage tolerance: ± 10 %

Insulation class: F

Protection class: IP 55

Rated power P_2 : 1.50 kW

Nominal current 3~230 V, 50 Hz I_N : 5.40 A

Nominal current 3~400 V, 50 Hz I_N : 3.10 A

Motor efficiency $\eta_{m 50\%}$: 80.5 %

Motor efficiency $\eta_{m 75\%}$: 83.7 %

Motor efficiency $\eta_{m 100\%}$: 84.2 %

Tender text: SiBoost Smart 3 Helix V 1004

Materials

Pump housing: 1.4301 [AISI304]

Pump shaft: 1.4301 [AISI304]

Impeller: 1.4307 [AISI304L]

Static seal: EPDM

Mechanical seal: Q1BE3GG

Connections

Nominal diameters of the pipe connections on suction side *RPS*: R 2½

Nominal diameters of pipe connections on the pressure side *RPD*: R 2½

Information for order placements

Weight approx. *m*: 217 kg

Type: SiBoost Smart 3 Helix V 1004

Art no.: 2536090