

Data sheet: Economy MHIL 304 (3~400 V)

Pump curves

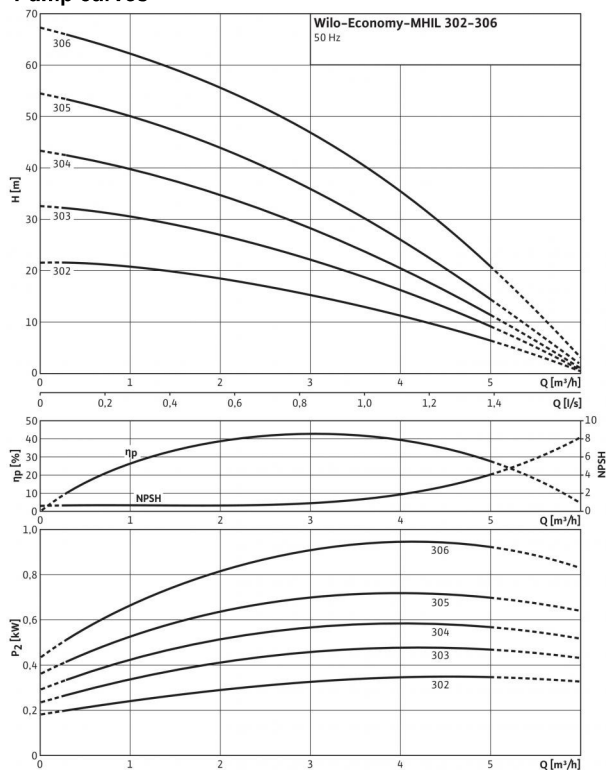

Pump curves in accordance with ISO 9906, class 2

Dimension drawing

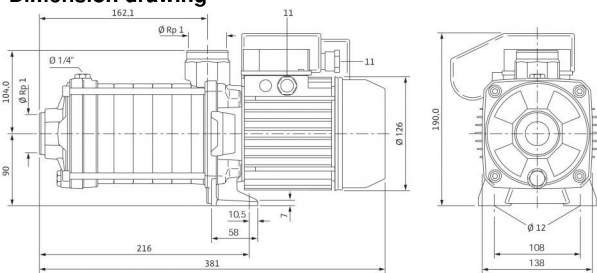

Terminal diagram

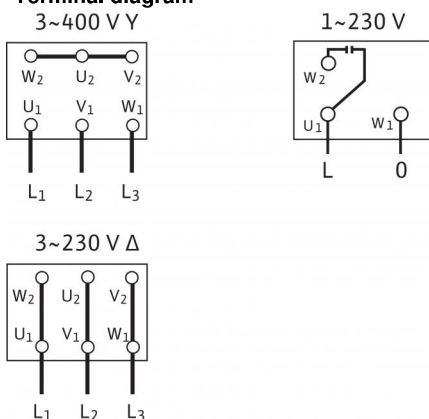

Approved fluids

Drinking water, heating water, process water	•
Condensate	-
Water/glycol mixtures (max. 40 %; with admixtures exceeding 10 %, the pumping data must be checked)	•
Other low viscous fluids (without abrasive or long-fibre constituents, provided they do not corrode the materials used)	•

Power

Fluid temperature T	-15...+90 °C
Max. ambient temperature T	40 °C
Rated pressure	PN bar
Inlet pressure max. H	6 bar
Maximum operating pressure p_{max}	10 bar
Nominal speed n	2900 rpm

Motor

Insulation class	F
Protection class	IP 54
Mains connection	3~400 V, 50 Hz
Rated power P_2	0.55 kW
Power consumption P_1	0.84 kW
Nominal current 3~230 V, 50 Hz I_N	2.7 A
Nominal current 3~400 V, 50 Hz I_N	1.56 A
Motor efficiency $\eta_{m 50\%}$	59.0 %
Motor efficiency $\eta_{m 75\%}$	64.3 %
Motor efficiency $\eta_{m 100\%}$	64.6 %

Connections

Rated pressure level (on the pressure side) PN	PN 10
Rated pressure level (on the suction side) PN	PN 10

Materials

Impeller	1.4301 [AISI304]
Stage chambers	1.4301 [AISI304]
Pump housing	EN-GJL-250 (cataphoretic-coated)
Pump shaft	1.4028 [AISI420F]
Housing cover	EN-GJL-250 (cataphoretic-coated)
Lower housing section	EN-GJL-250 (cataphoretic-coated)
Pressure shroud	-
Bearing	Tungsten carbide
Pump base	EN-GJL-250 (cataphoretic-coated)
Pump base (in contact with the fluid)	-
Static seal	EPDM
Mechanical seal	BQ1E3GG

Information for order placements

Make	Wilo
Type	MHIL 304
Art no.	4083899
Weight approx. m	13.2 kg

• = available, - = not available

Dimensions and dimensions drawings: Economy MHIL 304 (3~400 V)

Dimension drawing

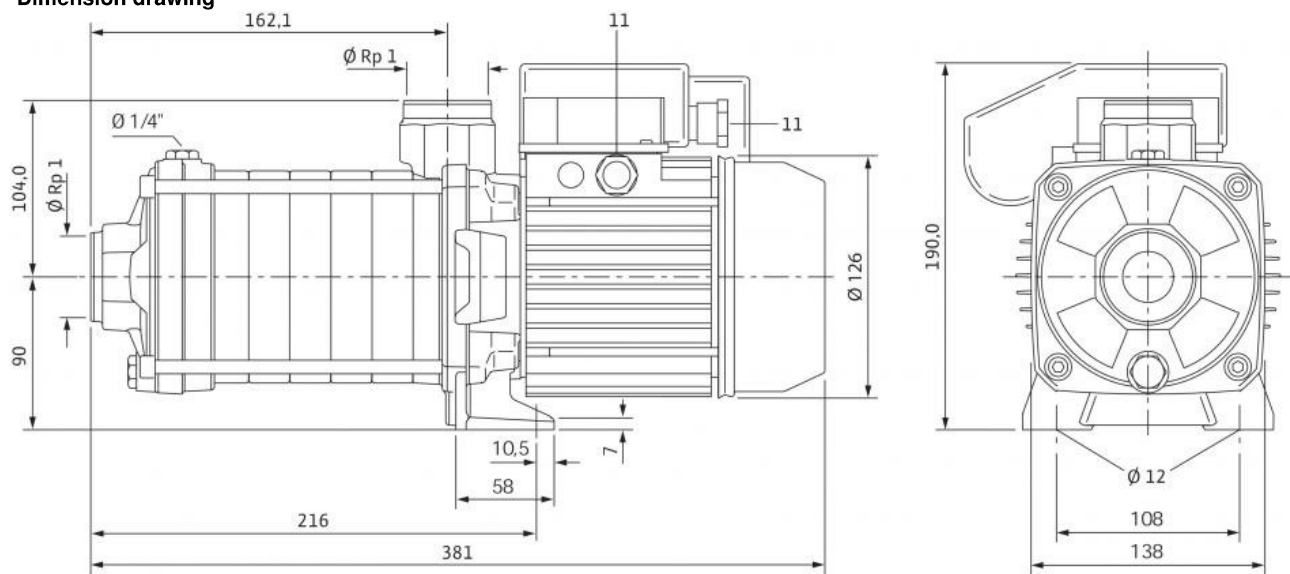

Pump curves: Economy MHIL 304 (3~400 V)

Pump curves

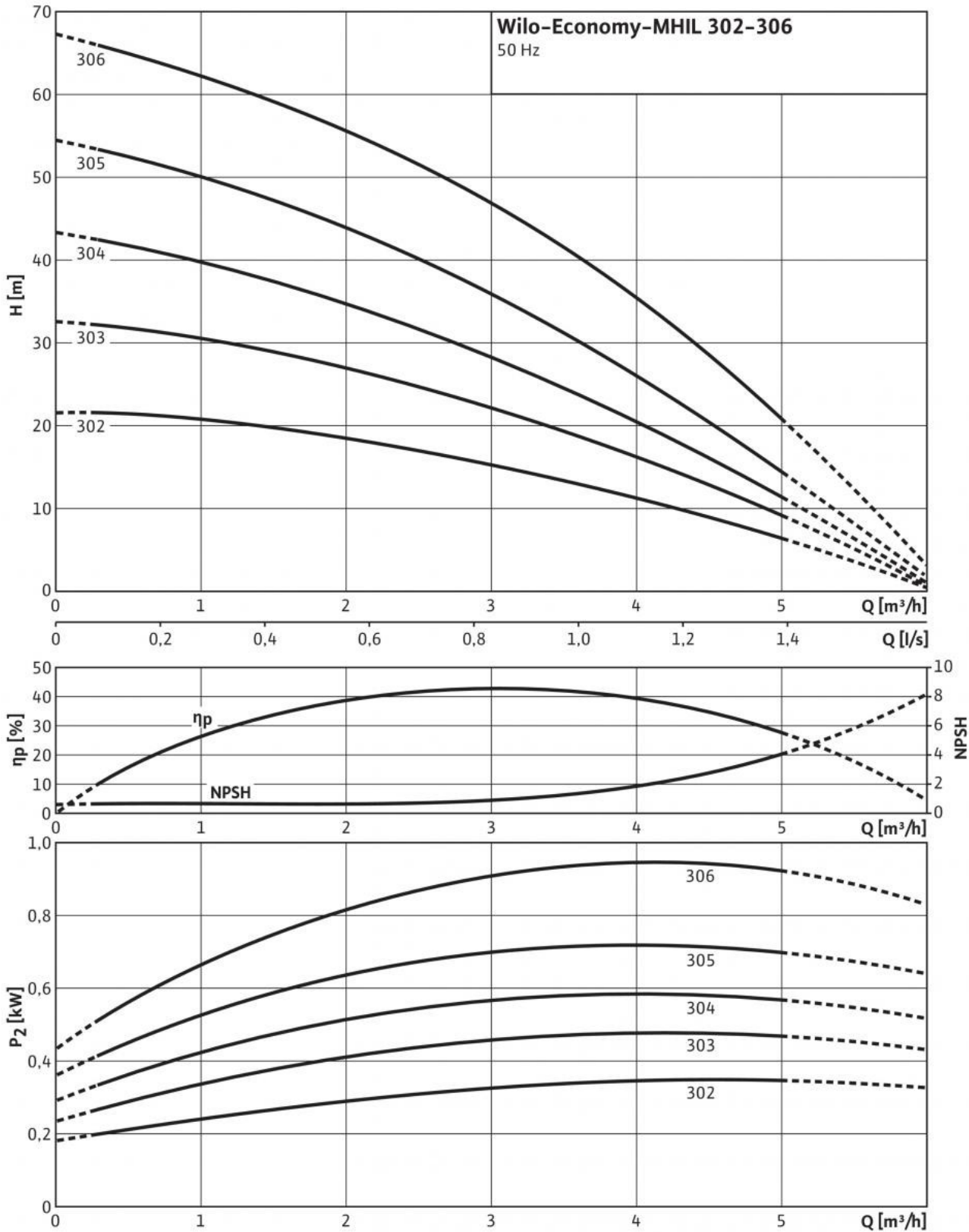

Pump curves in accordance with ISO 9906, class 2

Ordering information: Economy MHIL 304 (3~400 V)

Make	Wilo
Type	MHIL 304
Art no.	4083899
EAN number	4016322721284
Colour	Green/black/silver
Minimum order quantity	1
Minimum order quantity unit	PCE
Weight (net) <i>kg</i>	13.2
Length (net) <i>mm</i>	380.6
Width (net) <i>mm</i>	138
Height (net) <i>mm</i>	190
Weight (gross) <i>kg</i>	14.7
Length (gross) <i>mm</i>	600
Width (gross) <i>mm</i>	260
Height (gross) <i>mm</i>	280
Packaging type	One-way pallet
Packaging property	Transport packaging
Pieces per pallet	1
Number per layer	1

Tender text: Economy MHIL 304 (3~400 V)

Multistage, non-self-priming, horizontal high-pressure centrifugal pump in block design with horizontal suction- and vertical pressure port.

The pump has a compact design with a continuous motor pump shaft and a bidirectional mechanical seal. Stage chambers, impellers and diffusers are made of stainless steel and pump housing is made of cataphoretic-coated cast iron.

It is suitable for water supply and pressure boosting, industrial recirculation systems, process water and cooling water circuits. It can also be used in washing systems as well as for irrigation.

Special features/product advantages

- Space-saving, compact block design

Scope of delivery

- Wilo-MHIL high-pressure multistage centrifugal pump
- Installation and operating instructions

Design notes

- Motor protection for three-phase AC motor is optional or to be provided on-site
- Single-phase AC motor equipped with built-in thermal motor protection and capacitor

Materials

Impeller: 1.4301 [AISI304]

Stage chambers: 1.4301 [AISI304]

Pump housing: EN-GJL-250 (cataphoretic-coated)

Pump shaft: 1.4028 [AISI420F]

Housing cover: EN-GJL-250 (cataphoretic-coated)

Lower housing section: EN-GJL-250 (cataphoretic-coated)

Pressure shroud: –

Bearing: Tungsten carbide

Pump base: EN-GJL-250 (cataphoretic-coated)

Pump base (in contact with the fluid): –

Static seal: EPDM

Mechanical seal: BQ1E3GG

Approved fluids

Drinking water, heating water, process water: •

Condensate: -

Water/glycol mixtures (max. 40 %; with admixtures exceeding 10 %, the pumping data must be checked): •

Other low viscous fluids (without abrasive or long-fibre constituents, provided they do not corrode the materials used): •

Power

Fluid temperature T : -15...+90 °C

Max. ambient temperature T : 40 °C

Operating pressure: 10 bar

Inlet pressure max. H : 6 bar

Nominal speed n : 2900 rpm

Motor

Insulation class: F

Protection class: IP 54

Mains connection: 3~400 V, 50 Hz

Rated power P_2 : 0.55 kW

Power consumption P_1 : 0.84 kW

Nominal current 3~230 V, 50 Hz I_N : 2.7 A

Nominal current 3~400 V, 50 Hz I_N : 1.56 A

Motor efficiency $\eta_{m 50\%}$: 59.0 %

Motor efficiency $\eta_{m 75\%}$: 64.3 %

Motor efficiency $\eta_{m 100\%}$: 64.6 %

Connections

Nominal diameter of pipe connections on suction side R_p : 1

Nominal diameter of pipe connections on pressure side R_p : 1

Flange connections PN 16/PN 25 DN : –

Victaulic connections: –

Tender text: Economy MHIL 304 (3~400 V)

Information for order placements

Make: Wilo

Type: MHIL 304

Art no.: 4083899

Weight approx. *m*: 13.2 kg