

Data sheet: Economy MHI 803 (3~400 V, FKM)

Pump curves

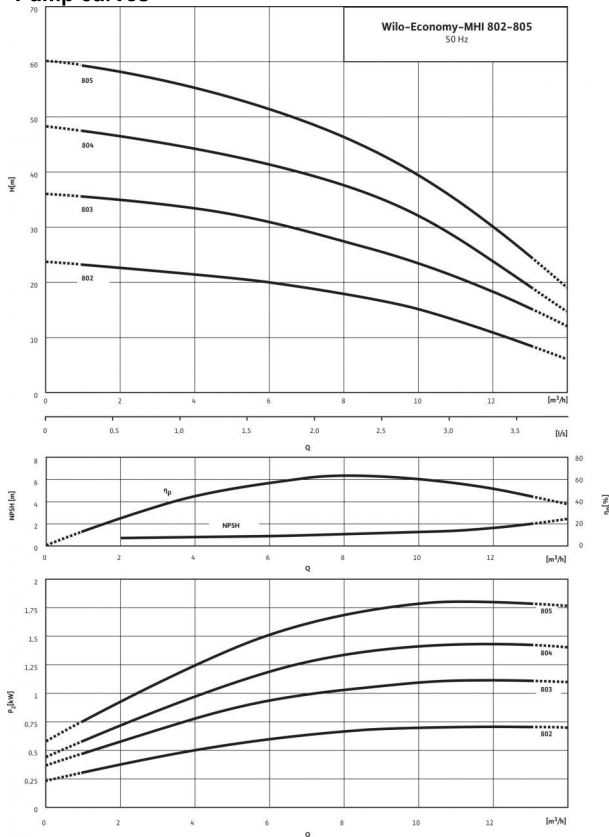

Pump curves in accordance with ISO 9906: 2012 3B

Dimension drawing

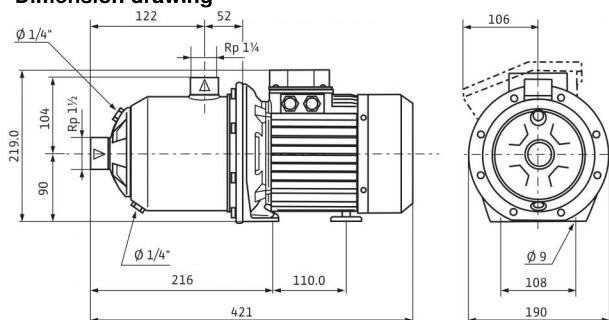

Terminal diagram

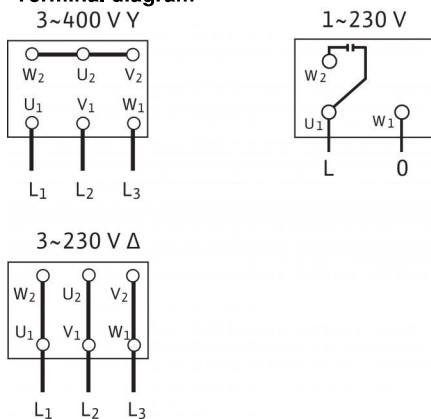

Power

Fluid temperature T	-15...+90 °C
Max. ambient temperature T	40 °C
Rated pressure	PN bar
Inlet pressure max. H	6 bar
Maximum operating pressure p_{max}	10 bar

Motor

Insulation class	F
Protection class	IP 54
Mains connection	3~400 V, 50 Hz
Rated power P_2	1.10 kW
Power consumption P_1	1.58 kW
Nominal current 3~230 V, 50 Hz I_N	4.8 A
Nominal current 3~400 V, 50 Hz I_N	2.8 A
Motor efficiency η_m 50%	81.5 %
Motor efficiency η_m 75%	82.7 %
Motor efficiency η_m 100%	82.7 %

Connections

Rated pressure level (on the pressure side) PN	PN 10
Rated pressure level (on the suction side) PN	PN 10

Materials

Impeller	1.4404 [AISI316L]
Pump housing	1.4404 [AISI316L]
Pump shaft	1.4404 [AISI316L]
Static seal	FKM
Mechanical seal	Q1BVG

Information for order placements

Make	Wilo
Type	MHI 803
Art no.	4210746
Weight approx. m	14.1 kg

• = available, - = not available

Note on inlet pressure

The maximum inlet pressure is calculated by subtracting the maximum delivery head of the pump at $Q=0$ from the maximum operating pressure of the system.

Note on materials

1.4301 corresponds to AISI 304, 1.4404 corresponds to AISI 316L.

Dimensions and dimensions drawings: Economy MHI 803 (3~400 V, FKM)

Dimension drawing

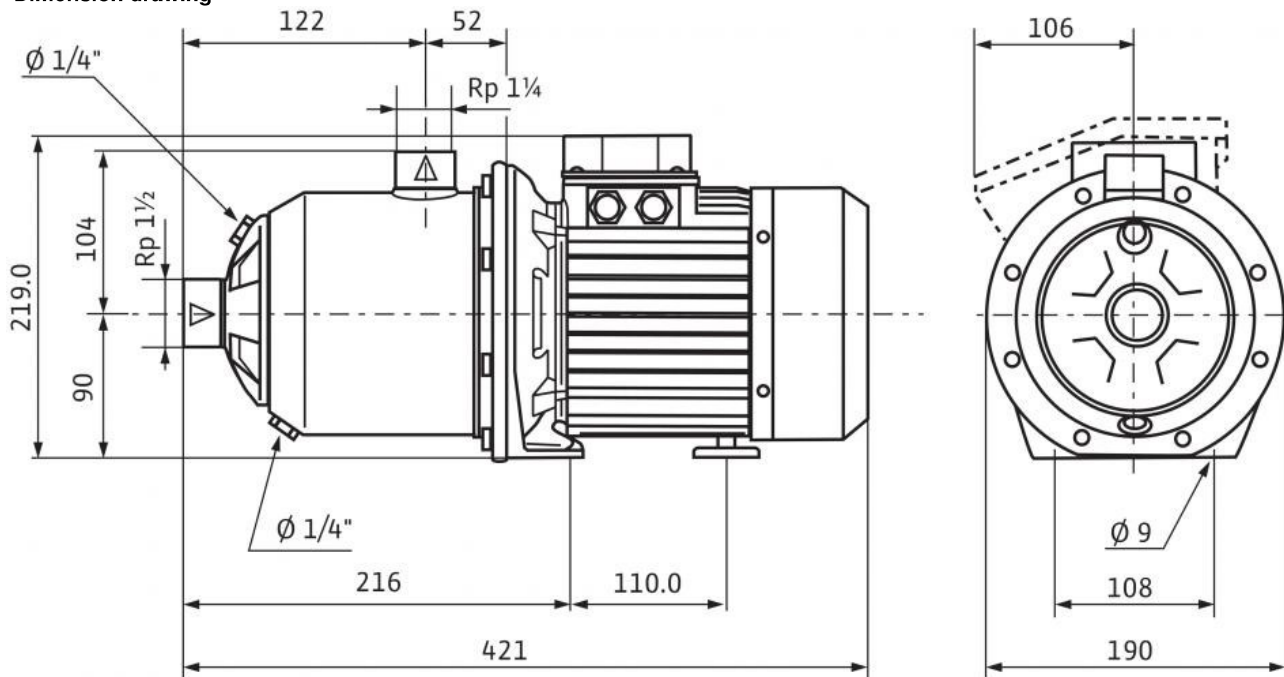

Pump curves: Economy MHI 803 (3~400 V, FKM)

Pump curves

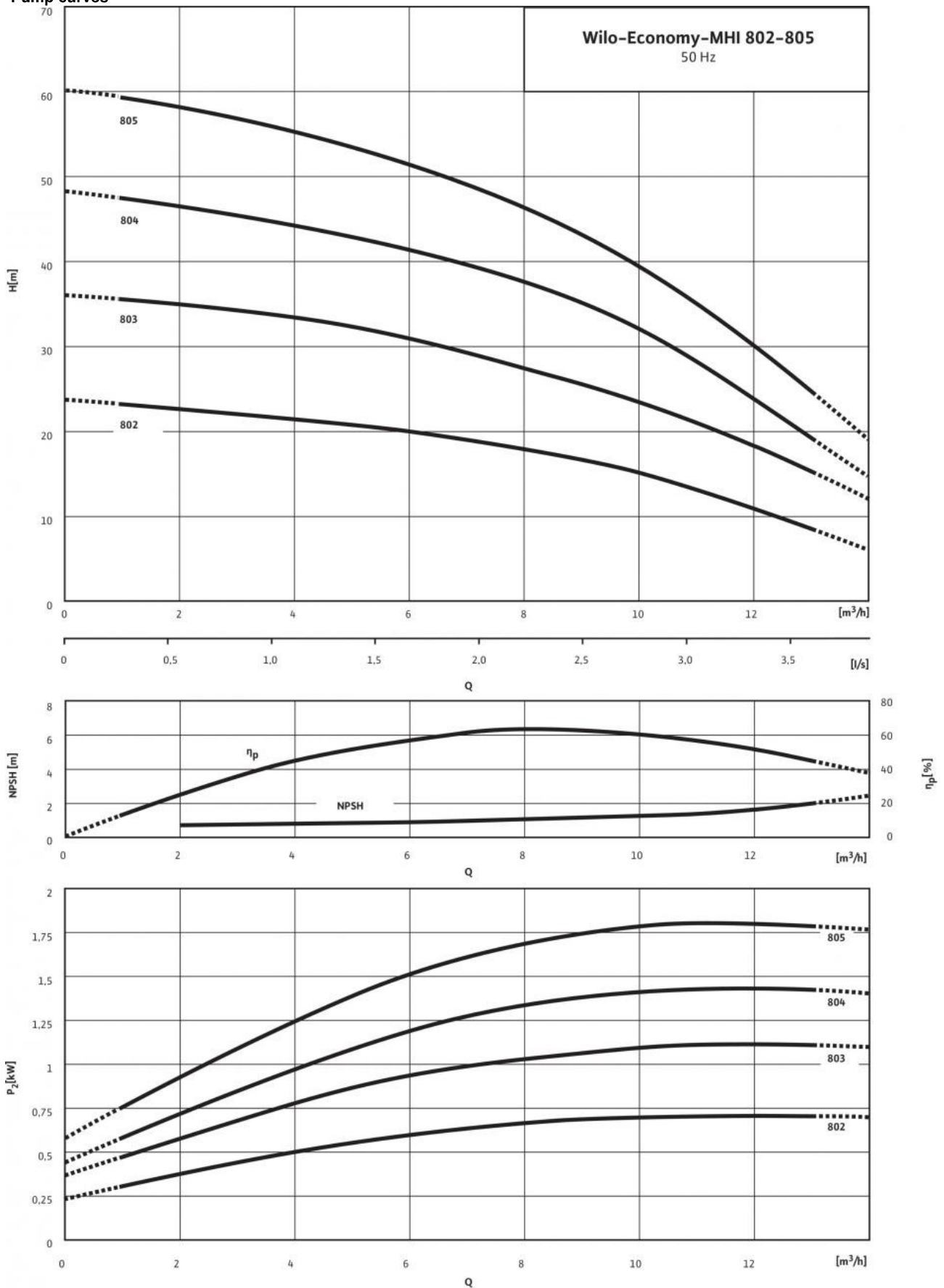

Ordering information: Economy MHI 803 (3~400 V, FKM)

Make	Wilo
Type	MHI 803
Art no.	4210746
EAN number	4048482692029
Colour	green/silver
Minimum order quantity	1
Minimum order quantity unit	PCE
Weight (net) <i>kg</i>	14.1
Length (net) <i>mm</i>	463
Width (net) <i>mm</i>	190
Height (net) <i>mm</i>	219
Weight (gross) <i>kg</i>	15.6
Length (gross) <i>mm</i>	600
Width (gross) <i>mm</i>	260
Height (gross) <i>mm</i>	280
Packaging type	Cardboard box
Packaging property	Transport packaging
Pieces per pallet	1
Number per layer	1

Tender text: Economy MHI 803 (3~400 V, FKM)

Multistage, non-self-priming, horizontal high-pressure centrifugal pump in block design with horizontal suction- and vertical pressure port.

The pump has a compact design with a continuous motor pump shaft and a bidirectional mechanical seal.

The pump is suitable for water supply and pressure boosting, industrial recirculation systems, process water and closed cooling circuits. It can also be used in washing systems, irrigation as well as for water treatment.

Special features/product advantages

- Space-saving, compact block design
- All hydraulic parts which come into contact with the fluid, such as stage chambers, impellers and guide vanes and the pump housing are made of stainless steel
- Drinking water approval (ACS, KTW, WRAS) for all components in contact with the fluid (EPDM version)

Scope of delivery

- Wilo-Economy MHI high-pressure multistage centrifugal pump
- Installation and operating instructions

Design notes

- Motor protection for three-phase AC motor is optional or to be provided on-site
- Single-phase AC motor equipped with built-in thermal motor protection and capacitor

Materials

Impeller: 1.4404 [AISI316L]
Pump housing: 1.4404 [AISI316L]
Pump shaft: 1.4404 [AISI316L]
Static seal: FKM
Mechanical seal: Q1BVG

Power

Fluid temperature T : -15...+90 °C
Max. ambient temperature T : 40 °C
Inlet pressure max. H : 6 bar

Motor

Insulation class: F
Protection class: IP 54
Mains connection: 3~400 V, 50 Hz
Rated power P_2 : 1.10 kW
Power consumption P_1 : 1.58 kW
Nominal current 3~230 V, 50 Hz I_N : 4.8 A
Nominal current 3~400 V, 50 Hz I_N : 2.8 A
Motor efficiency $\eta_{m 50\%}$: 81.5 %
Motor efficiency $\eta_{m 75\%}$: 82.7 %
Motor efficiency $\eta_{m 100\%}$: 82.7 %

Connections

Nominal diameter of pipe connections on suction side R_p : 1½
Nominal diameter of pipe connections on pressure side R_p : 1¼

Information for order placements

Make: Wilo
Type: MHI 803
Art no.: 4210746
Weight approx. m : 14.1 kg